



PRODOTTI

 **Va.li.co**

The logo for Va.li.co, featuring a stylized white triangle composed of horizontal lines to the left of the text 'Va.li.co' in a bold, white, sans-serif font.

CATALOGO GENERALE
INVERTER

SIAMO SEMPRE ONLINE

FORNIAMO COMPONENTI ORIGINALI O INTERCAMBIABILI
PER OGNI TIPOLOGIA DI IMPIANTI.

Hai bisogno di informazioni utili
oppure di assistenza immediata?



COME ORDINARE SU:
WWW.SSPRICAMBI.NET

CERCA I PRODOTTI

NELLA BARRA DI RICERCA, OPPURE SFOGLIA PER CATEGORIA

CODICE	DESCRIZIONE	€	
000001	IL TUO PRODOTTO	€ 50,29	
000002	IL TUO PRODOTTO	€ 51,68	
000003	IL TUO PRODOTTO	€ 79,50	



METTILI NEL CARRELLO

ACCEDI CON IL TUO ACCOUNT PER USARE LA SCONTISTICA PERSONALE
EFETTUA IL BONIFICO PER COMPLETARE L'ORDINE



RICEVI CON SPEDIZIONI GIORNALIERE

TNT TRACO

S&SP
SERVICE & SPARE PARTS



S&SP
SERVICE & SPARE PARTS



PASSIONE PER L'INDUSTRIA MODERNA.

**DAI RICAMBI ALLA COSTRUZIONE DI IMPIANTI
NEL SETTORE AEROSPAZIALE, INSIEME ALLE AZIENDE PER ASSISTERLE
E AIUTARLE AD AGGIORNARE I LORO SISTEMI PRODUTTIVI.**





PRODOTTI

 **Va.li.co**

INVERTER

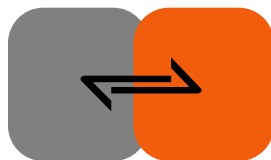

INVT - GD20

Caratteristica		Specifiche									
Linea	Modello	GD20-EU									
1f. 230V	GD20-EU	0R4G-S2	0R7G-S2	1R5G-S2	2R2G-S2						
I nom.	carico HD (A)	2.5	4.2	7.5	10						
Motore	carico HD (KW)	0.4	0.75	1.5	2.2						
3f. 230V	GD20-EU	0R4G-2	0R7G-2	1R5G-2	2R2G-2	004G-2	5R5G-2	7R5G-2			
I nom.	carico HD (A)	2.5	4.2	7.5	10	16	20	30			
Motore	carico HD (KW)	0.4	0.75	1.5	2.2	4.0	5.5	7.5			
3f. 400V	GD20-EU	0R7G-4	1R5G-4	2R2G-4	004G-4	5R5G-4	7R5G-4	011G-4	015G-4	018G-4	
I nom.	carico HD (A)	2.5	4.2	5.5	9.5	14	18.5	25	32	38	
Motore	carico HD (KW)	0.75	1.5	2.2	4	5.5	7.5	11	15	18.5	
3f. 400V	GD20-EU	022G-4	030G-4	037G-4	045G-4	055G-4	075G-4	090G-4	110G-4		
I nom.	carico HD (A)	45	60	75	92	115	150	180	215		
Motore	carico HD (KW)	22	30	37	45	55	75	90	110		
Range di alimentazione	Classe 400V: 323-484Vca 50-60Hz. Classe 230V: 187-264Vca 50-60Hz.										
Fattore di sovraccarico	Carico gravoso: 150% per 60 sec., 180% per 10 sec., 200% per 1sec. Verificare sul manuale le temperature massime di impiego ed i valori di frequenza PWM per raggiungere i valori di corrente indicati.										
Chopper di frenatura	Integrato fino a GD20-037G-4 incluso. Oltre esterno opzionale										
Filtro EMC	Integrato compatibile con EN61800-3 C3 sui modelli con potenza di 4KW e oltre. Modulo filtro add-on per i modelli di potenza inferiore.										

Classe di tensione	Potenza motore HD (KW)	Tipo inverter	Dimensioni (mm)			Montaggio
			W larghezza	H altezza	D profondità	
230V monofase 230V trifase	0.4	GD20-0R4G-S2/2	80	160/185	123.5/140.5	Montaggio a parete
	0.75	GD20-0R7G-S2/2				
	1.5	GD20-1R5G-S2/2	80/146	185/256	140.5/167	
	2.2	GD20-2R2G-S2/2				
230V trifase	4	GD20-004G-2	146	256	167	
	5.5	GD20-5R5G-2	170	320	196.3	
	7.5	GD20-7R5G-2				
400V trifase	0.75	GD20-0R7G-4	80	185	140.5	
	1.5	GD20-1R5G-4				
	2.2	GD20-2R2G-4				
	4	GD20-004G-4	146	256	167	
	5.5	GD20-5R5G-4				
	7.5	GD20-7R5G-4	170	320	196.3	
	11	GD20-011G-4				
	15	GD20-015G-4				
	18.5	GD20-018G-4	200	340.6	184.3	
	22	GD20-022G-4				
	30	GD20-030G-4	250	400	202	
	37	GD20-037G-4				
45	GD20-045G-4	282	560	238		
55	GD20-055G-4					
75	GD20-075G-4					
90	GD20-090G-4	338	554	329.2		
110	GD20-110G-4					



Dimension (unit: mm)

Model	W1	W2	H1	H2	D1	D2	Hole (d)
GD20-0R4G-S2-EU	80.0	80.0	160.0	150.0	123.5	120.3	5
GD20-0R7G-S2-EU	80.0	80.0	160.0	150.0	123.5	120.3	5
GD20-1R5G-S2-EU	80.0	80.0	185.0	175.0	140.5	137.3	5
GD20-2R2G-S2-EU	80.0	80.0	185.0	175.0	140.5	137.3	5
GD20-0R4G-2-EU	80.0	80.0	185.0	175.0	140.5	137.3	5
GD20-0R7G-2-EU	80.0	80.0	185.0	175.0	140.5	137.3	5
GD20-0R7G-4-EU	80.0	80.0	185.0	175.0	140.5	137.3	5
GD20-1R5G-4-EU	80.0	80.0	185.0	175.0	140.5	137.3	5
GD20-2R2G-4-EU	80.0	80.0	185.0	175.0	140.5	137.3	5

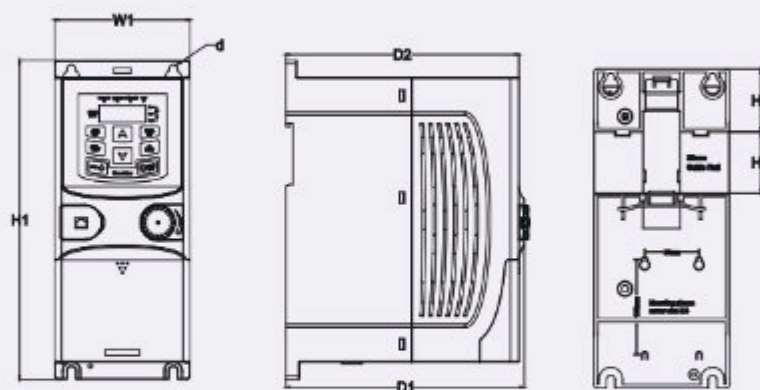

Rail mounting of inverters of 1PH 230V/3PH 380V ($\leq 2.2\text{kW}$) and 3PH 230V ($\leq 0.75\text{kW}$)

Dimension (unit: mm)

Model	W1	W2	H1	H2	D1	D2	Hole (d)
GD20-0R4G-S2-EU	80.0	160.0	35.4	36.6	123.5	120.3	5
GD20-0R7G-S2-EU	80.0	160.0	35.4	36.6	123.5	120.3	5
GD20-1R5G-S2-EU	80.0	185.0	35.4	36.6	140.5	137.3	5
GD20-2R2G-S2-EU	80.0	185.0	35.4	36.6	140.5	137.3	5
GD20-0R4G-2-EU	80.0	185.0	35.4	36.6	140.5	137.3	5
GD20-0R7G-2-EU	80.0	185.0	35.4	36.6	140.5	137.3	5
GD20-0R7G-4-EU	80.0	185.0	35.4	36.6	140.5	137.3	5
GD20-1R5G-4-EU	80.0	185.0	35.4	36.6	140.5	137.3	5
GD20-2R2G-4-EU	80.0	185.0	35.4	36.6	140.5	137.3	5

STRUMENTI

MANOMETRI - TERMOMETRI - PT100 - MISURATORI DI PORTATA - TRASETTITORI DI PRESSIONE
REGOLATORI E STRUMENTI PNEUMATICI



PERSONALIZZAZIONI A RICHIESTA

Hai bisogno di informazioni utili
oppure di assistenza immediata?



CHIEDI AL TECNICO
NUMERO WHATSAPP



VALVOLE A TRE VIE DI REGOLAZIONE

MATERIALI: GHISA-WCB-INOX
PER VAPORE E OLIO DIATERMICO



MOVIMENTO E CONTROLLO

MOTORI - RIDUTTORI - INVERTER - SENSORI



POMPE

ELETTROPOMPE CENTRIFUGHE IN GHISA E INOX
POMPE DOSATRICI
POMPE A MEMBRANA



DISPONIBILI - DISPONIBILI - DISPONIBILI - DISPONIBILI - DISPONIBILI -

DISPONIBILI - DISPONIBILI - DISPONIBILI - DISPONIBILI - DISPONIBILI -

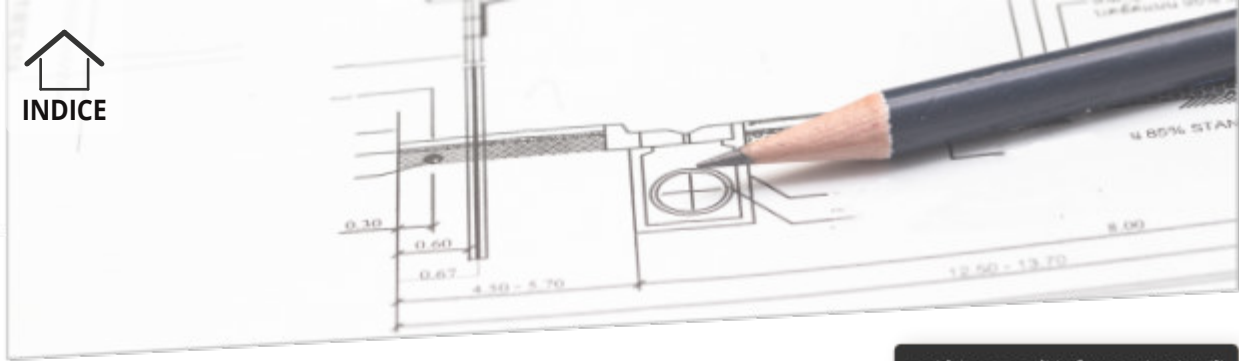

Hai bisogno di informazioni utili
oppure di assistenza immediata?

CHIEDI AL TECNICO
NUMERO WHATSAPP

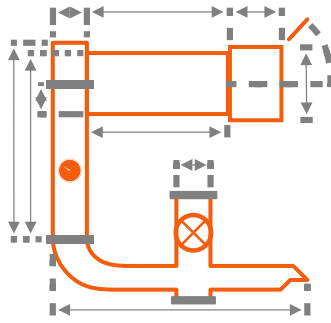

PER VISITARE QUESTA PAGINA
WEB E I SERVIZI CORRELATI,
SCANSIONA IL QR CODE CON IL
TUO SMARTPHONE O TABLET



REALIZZATO UNICAMENTE PER VOI.

PARTICOLARI E COMPONENTI SU MISURA
CHE PARTONO DALLA NECESSITÀ DEL
CLIENTE, PASSANDO ALLO SVILUPPO DEL
PROGETTO, FINO ALLA SUA
REALIZZAZIONE.

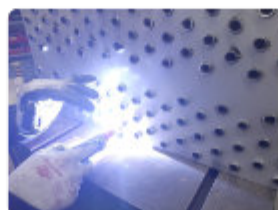
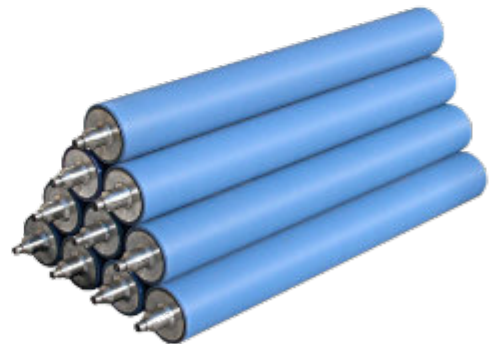
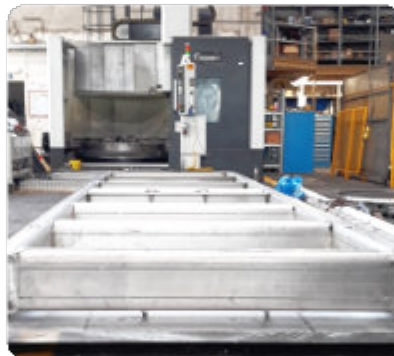

SSP SRL

Sede legale - Stabilimento
Via per Cavolto 27
22040 Anzano del Parco (Co)
sito web: www.sspsrl.net

P IVA e CF: 03518440122
Registro Imprese T203770732
Tel +39 031 41 34 797
info@sspsrl.net